

NFB 5 DIAPHRAGM LIQUID PUMP

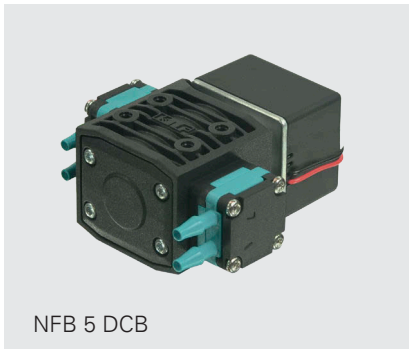

NFB 5 DCB

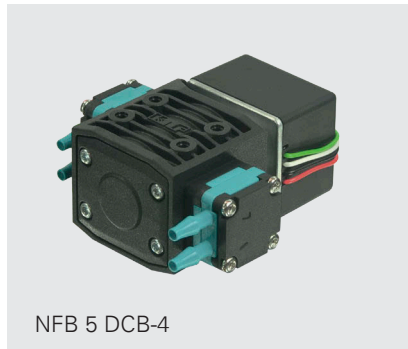

NFB 5 DCB-4

ADVANTAGES

- Small and powerful
- Self priming and excellent for pressure
- Extreme chemical resistance
- Dry running, durable and maintenance free
- Low pulsation
- Two-in-one

POSSIBLE AREAS OF USE

- Analysers
- Laboratory
- Cleaning industry
- Printing

Please visit our website
www.knf.com
to get more information.

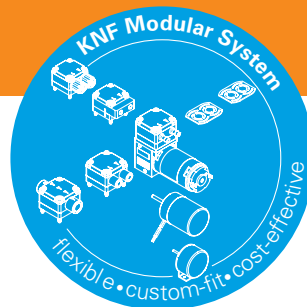

PERFORMANCE DATA			
Basic types	NFB 5 DCB		NFB 5 DCB-4
Material options	KP	KT	TT
Pump head	PP	PP	PVDF
Diaphragm	EPDM	PTFE	PTFE
Valves	EPDM	FFKM	FFKM
Flow rate (ml/min) at atm. pressure	2x ≥40		2x ≥5 - 40
Suction height (mWg)	3		
Pressure head (mWg)	10		
Permissible ambient temperature (°C)	+5 bis +40		
Permissible liquid temperature (°C)	+5 bis +80		
Weight (g)	75		
IP protection factor	40		
ELECTRICAL DATA			
Operating voltage (V)	12 / 24		10 - 26.4
Power consumption (W)	1.6 / 1.9		2.1
I load max. (A)	0.13 / 0.08		0.08 - 0.19

NFB 5 DCB

PERFORMANCE DATA

Series model	Flow rate at atm. pressure (ml/min)	Max. suction height (mWg)	Max. pressure head (mWg)
NFB 5 DCB	2x ≥40	3	10

NFB 5 DCB

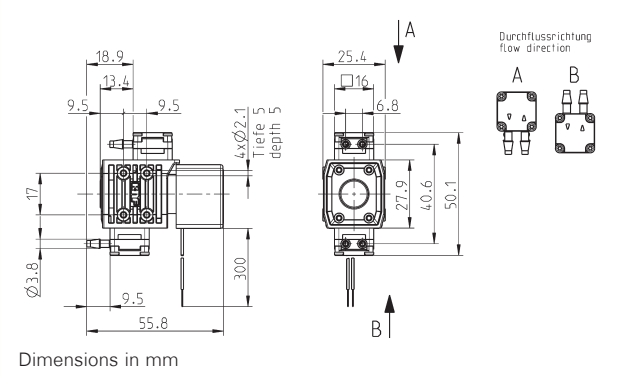

NFB 5 DCB FLOW CURVE (PER HEAD)

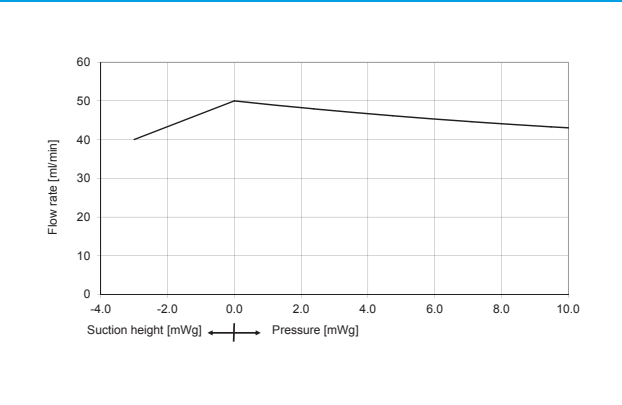

NFB 5 DCB-4

PERFORMANCE DATA

Series model	Flow rate at atm. pressure (ml/min)	Max. suction height (mWg)	Max. pressure head (mWg)
NFB 5 DCB-4	2 x 5-50	3	10

NFB 5 DCB-4

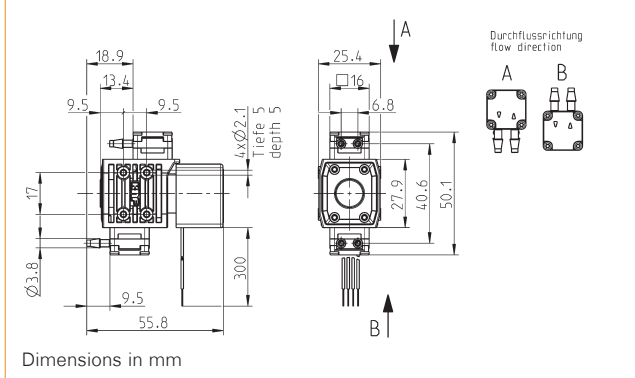

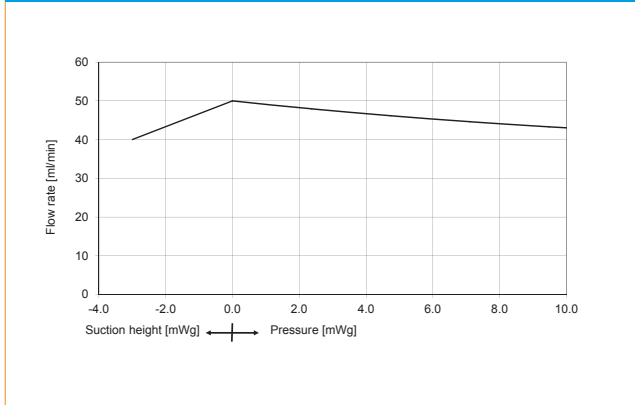

NFB 5 DCB-4 FLOW CURVE (PER HEAD)



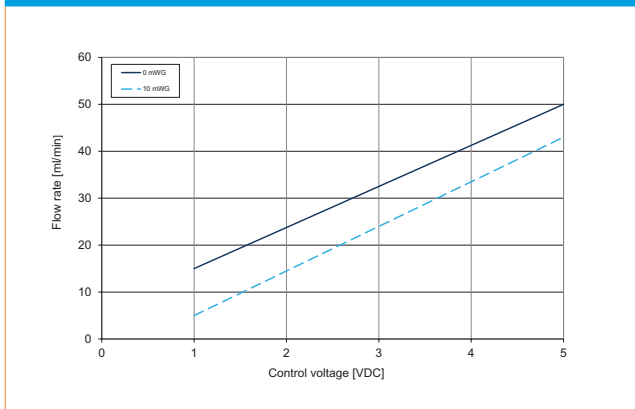



NFB 5 DCB-4 CONTROL CURVE (PER HEAD)



OPTIONS		
Name	Picture	Details
Electrical connections		Molex, AMP etc.
Hydraulic connections		Internal thread etc.

DIGITAL CUSTOMIZATION

Thanks to digital technology, this pump can be quickly adapted to the customer's system. This is done by parametrizing the firmware of the motor at KNF.

ACCESSORIES		
Description	Illustration	Details
Diaphragm pressure control valve		The pressure control valve can be used for a more accurate control of flow against a fluctuating back pressure, metering into a vacuum and from a pressurised system.
Pulsation damper		This very versatile pulsation damper reduces the vibration in hoses and pipes and it helps to remove pulsation which is preventing the system from functioning correctly.
Filter		KNF filters protect both pumps and other upstream instrumentation and hydraulic circuits against particulate, crystals and fibres which can improve optimum operation.
Tubing		Various diameters and materials

The performance values for the series models shown on this data sheet were determined under test conditions. The actual performance values may differ and depend in particular on the usage conditions and therefore on the specific application, on the parameters of the components involved in the user's system and on any technical modifications carried out which deviate from the standard configuration or the as delivered condition.

If individual designs have been created for specific customers on the basis of series models, other technical performance data may apply. Before operation begins, the relevant operating instructions and/or assembly or installation instructions should be read and the safety information contained in these instructions should be noted. KNF reserves the right to make changes to the product and the associated documentation without prior notice to the customer.



www.knf.com

KNF reserves the right to make technical changes without notice.
KNF 01/2019. www.knf.com