



# NF 10 DC

## PERFORMANCE DATA

Series model	Flow rate at atm. pressure (ml/min)	Max. suction height (mWg)	Max. pressure head (mWg)
NF 10 DC	100	3	10

## NF 10 DC

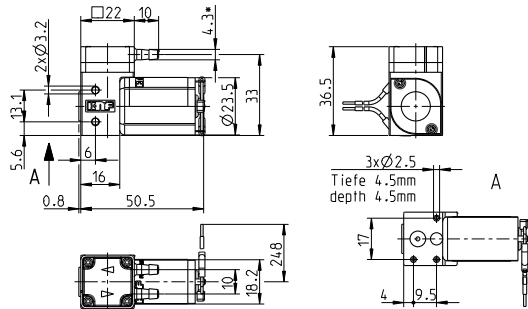

Dimensions in mm

## NF 10 DC FLOW CURVE

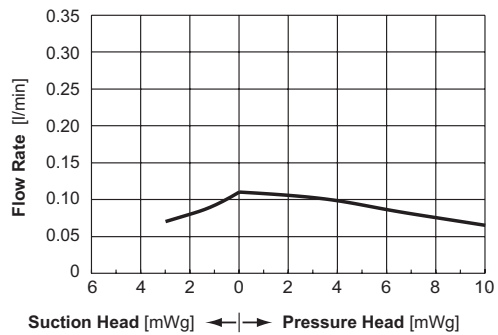

# NF 10 DCB

## PERFORMANCE DATA

Series model	Flow rate at atm. pressure (ml/min)	Max. suction height (mWg)	Max. pressure head (mWg)
NF 10 DCB	100	3	10

## NF 10 DCB

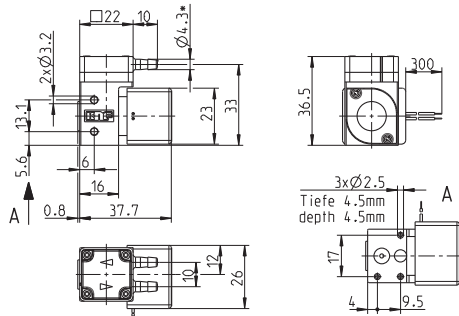

Dimensions in mm

## NF 10 DCB FLOW CURVE

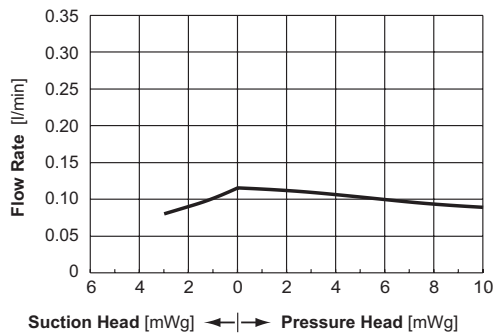

# NF 10 DCB-4

## PERFORMANCE DATA

Series model	Flow rate at atm. pressure (ml/min)	Max. suction height (mWg)	Max. pressure head (mWg)
NF 10 DCB-4	100	3	10

## NF 10 DCB-4

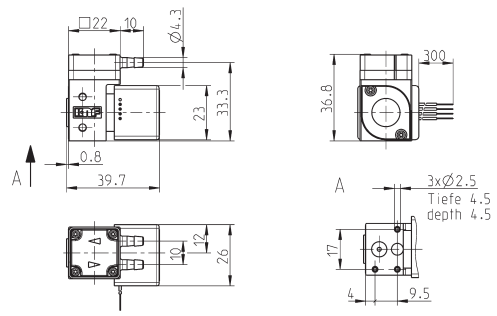



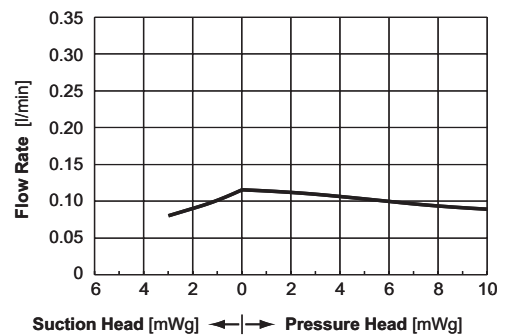

Dimensions in mm

## NF 10 DCB-4 FLOW CURVE

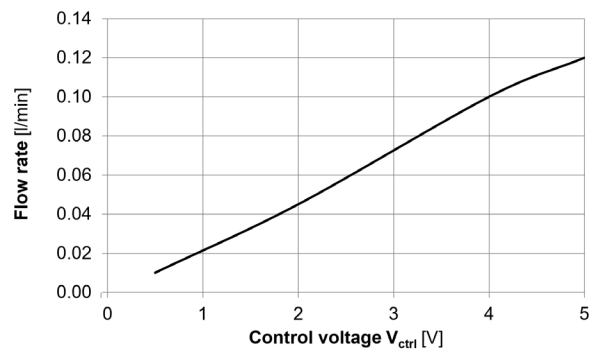

## NF 10 DCB-4 CONTROL CURVE



OPTIONS		
Name	Picture	Details
Motors		Various voltage options, higher and lower service life
Electrical connections		Molex, AMP etc.
Hydraulic connections		Internal thread, compression fittings etc.







### NSF National Sanitary Foundation

This certification will confirm that all of the pumps with the code .51 are certified for the use with foods/consumables.

### DIGITAL CUSTOMIZATION

Thanks to digital technology, this pump can be quickly adapted to the customer's system. This is done by parametrizing the firmware of the motor at KNF.

ACCESSORIES		
Description	Illustration	Details
Diaphragm pressure control valve		The pressure control valve can be used for a more accurate control of flow against a fluctuating back pressure, metering into a vacuum and from a pressurised system.
Pulsation damper		This very versatile pulsation damper reduces the vibration in hoses and pipes and it helps to remove pulsation which is preventing the system from functioning correctly.
Filter		KNF filters protect both pumps and other upstream instrumentation and hydraulic circuits against particulate, crystals and fibres which can improve optimum operation.
Tubing		Various diameters and materials

The performance values for the series models shown on this data sheet were determined under test conditions. The actual performance values may differ and depend in particular on the usage conditions and therefore on the specific application, on the parameters of the components involved in the user's system and on any technical modifications carried out which deviate from the standard configuration or the as delivered condition.

If individual designs have been created for specific customers on the basis of series models, other technical performance data may apply. Before operation begins, the relevant operating instructions and/or assembly or installation instructions should be read and the safety information contained in these instructions should be noted. KNF reserves the right to make changes to the product and the associated documentation without prior notice to the customer.



[www.knf.com](http://www.knf.com)

KNF reserves the right to make technical changes without notice.  
KNF 01/2019, [www.knf.com](http://www.knf.com)